

Analysis of cervical resistance during continuous contrrollable ballon dilatation

P.Arsenijević, S.Arsenijević and A.Živanović
GAK-KC-Kragujevac

Background

- Cervical dilatation is a term that refers mostly to the physiological dilatation that occurs during childbirth, although artificial dilatation of the cervical canal is a common procedure in gynaecological practice that is used for both therapeutic and diagnostic procedures.
- The most common method for cervical dilatation is dilatation with Hegar's dilators; this method requires the use of significant force, which may lead to permanent damage of the cervical canal. Other methods of cervical dilatation involve the use of osmotic dilators or prostaglandin analogues, which are impractical, often nonfunctional, and cause undesirable effects such as cervical haemorrhage or uterine cramping.

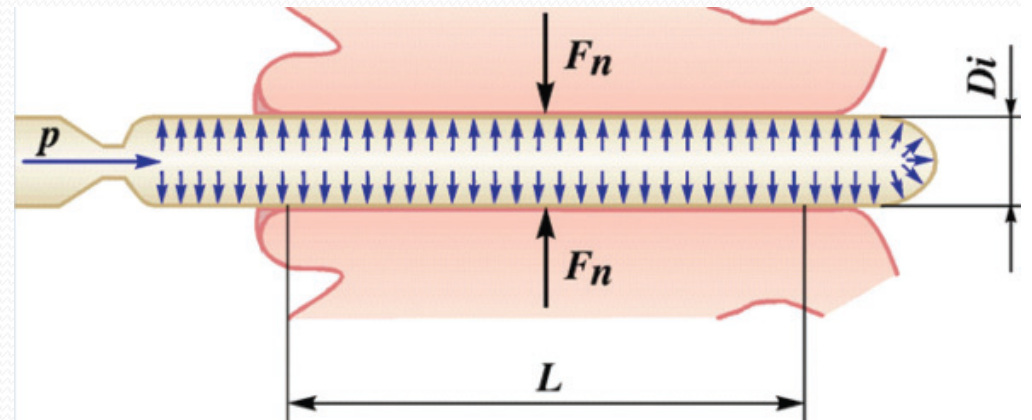
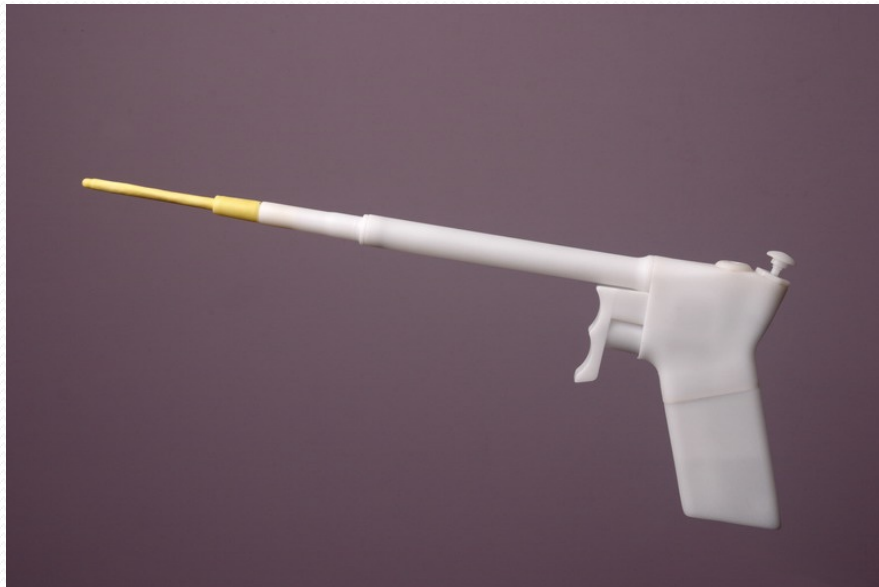
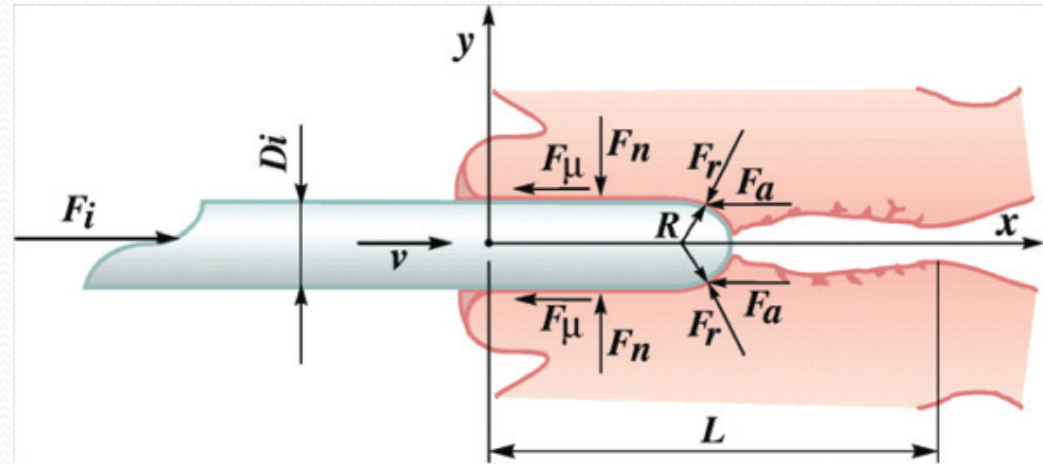
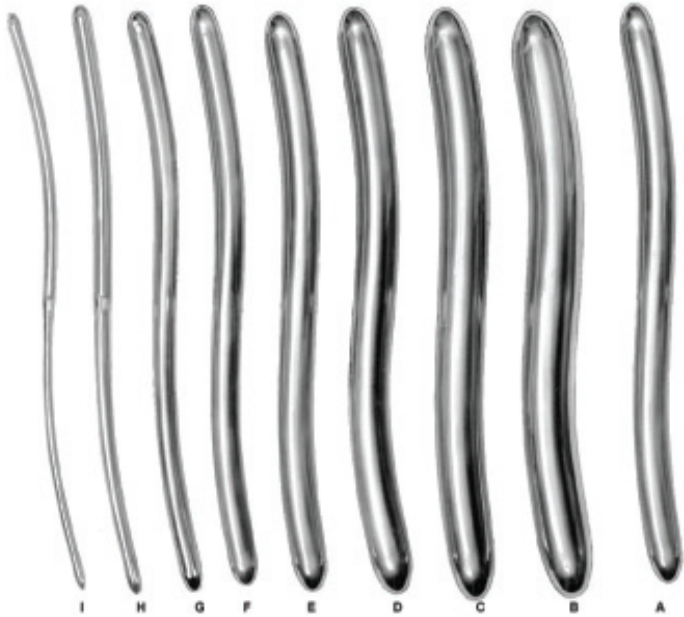

CCBD

- Cervical dilatation by continuous controllable balloon dilatation (CCBD) is relatively new method that is based on the continuous and controllable pumping of fluid into the balloon extension of the dilatation device.
- Less invasive method, which caused significantly less damage to the cervical tissue compared with Hegar's dilators.
- CCBD enables a safer and more reliable method of cervical dilatation and can also be used to monitor and analyse the insufficiently researched process of artificial dilatation of the uterine cervix.

Objectives

- The main aim of our research was to precisely measure, analyse and create a map along the cervical canal during the dilatation of the uterine cervix.

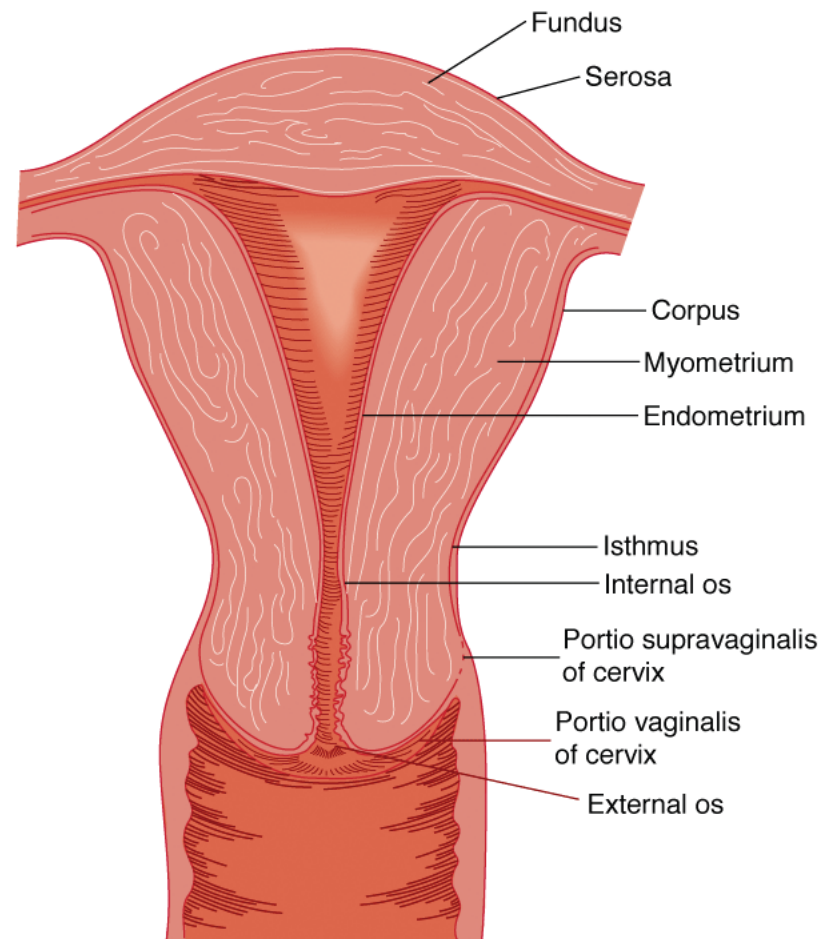

Methods

- **Study design:** The study was conducted as prospective, controlled, clinical and experimental study on the Clinic of Gynecology and Obstetric, Clinical centre, Kragujevac, Serbia.
- The study involved 42 women who were hospitalised for termination of an unwanted pregnancy in the Fertility control department.
- The inclusion criteria for the selection of patients were: age between 18-40, pregnancy verified by an ultrasound; singleton pregnancy; gestational age of 10 weeks or less; absence of uterine bleeding or cramping; cervix and uterus without pathological changes; closed external cervical os.

Study method

- In the upgraded CCBD system, controllability over the process of dilatation is met on two levels: **control over the maximum diameter of dilatation and control of the parameters of the dilatation process** (i.e., pressure in the balloon extension, dilatation speed). These two levels of control are reached by using the *Nexus 6000* hydrostatic pump (Chemyx Inc., Stafford, TX 77477, USA) and our original software application that allows the dilation process to operate under strictly controlled conditions (dilatation process lasted **100 seconds**, and the pressure in the balloon extension did not exceed **20 MPa**).

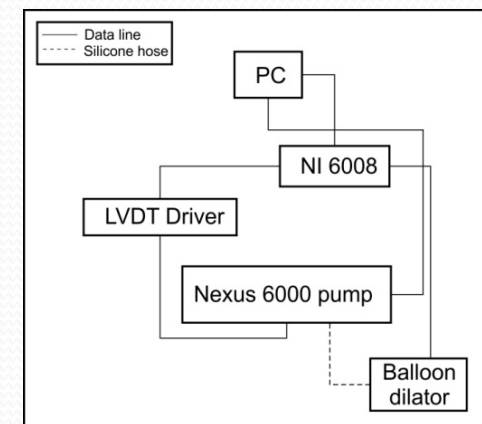
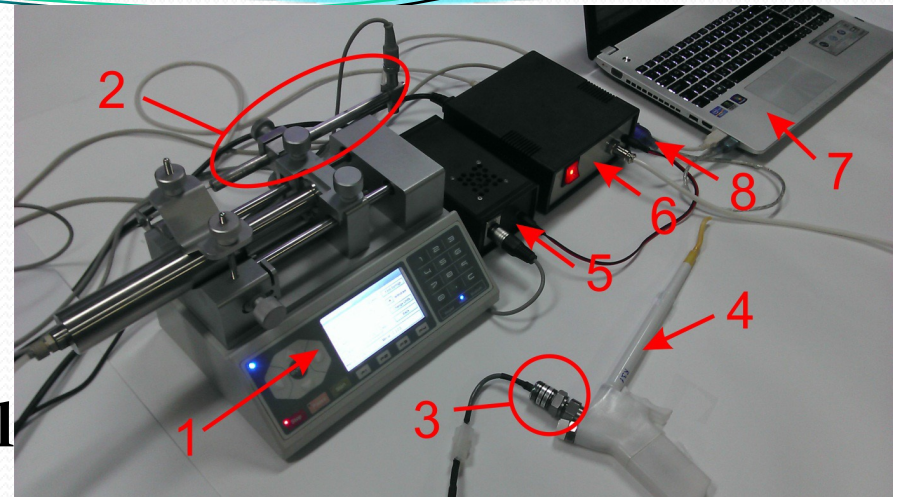

Scheme CCBD

1. PC
2. Acquisition card
3. Driver pressure sensor
4. Pressure sensor
5. Driver moving sensor
6. Moving sensor
7. USB to PC232 converter
8. Injection pump *Nexus 6000*

The tracking and measurement of the dilatation parameters were performed by the pressure sensor, which is located on the dilatator device as well as by the motion sensor, which is attached to the hydrostatic pump.

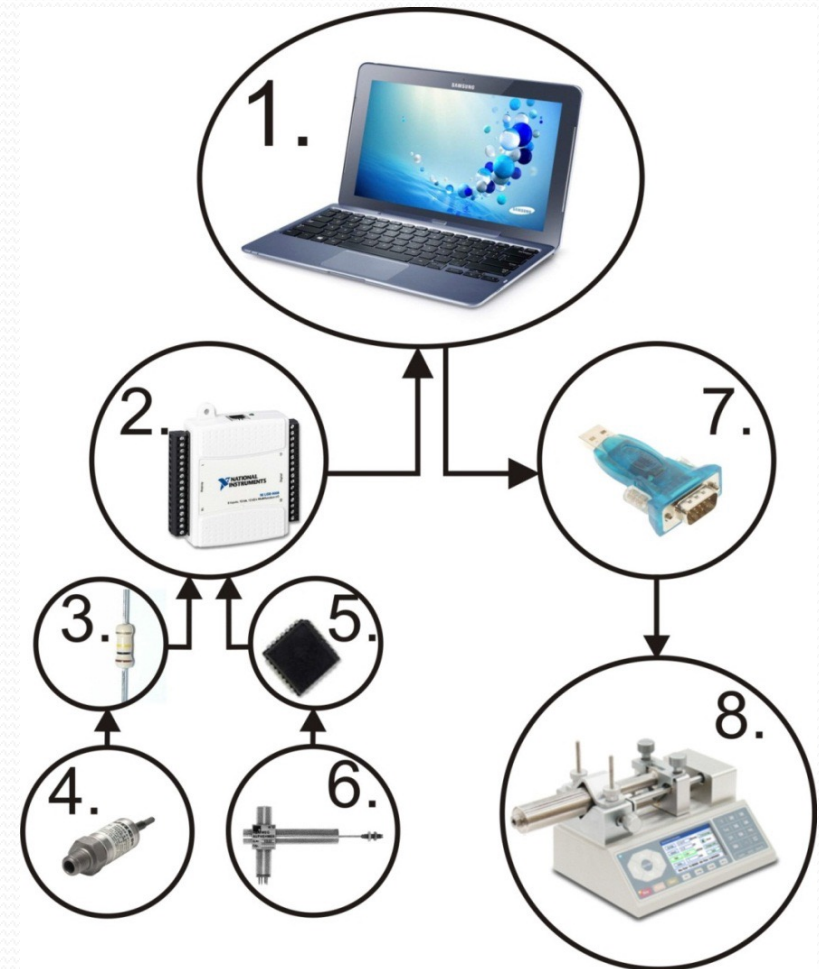

Pressure sensitive films

- In our aim to precisely measure and basically map the resistance along the cervical canal during CCBD, we used pressure-sensitive films (PSF): *FUJIFILM Ultra Super Low Pressure*.
- Under the influence of external force on the PSF, microcapsules in component A of the film rupture and the released red paint is absorbed by the special material in component B

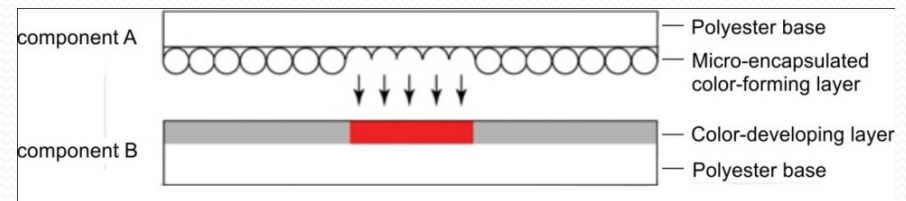

Pressure sensitive films

- The width of the PSF used in our study was 3 mm, and the length was 70 mm; adhesive tape was placed at both ends of the PSF in order to keep components A and B together during the experiment. We also placed adhesive tape at the top ends of the PSF in order to avoid their movement during the placement of the balloon extension in the cervical canal. Due to presence of cervical mucus and blood during the experiment, we had to isolate our PSF with transparent plastic foil.
- In every experiment, we used two PSFs, which were placed on the top and the bottom of the balloon extension of the CCBD system.

- 
- After the completion of the dilatation, the PSFs were collected, scanned and converted into their respective digital forms, which were further analysed by the *MatLab* program (MathWorks, Inc., Natick, Massachusetts, USA). The final versions of the processed PSFs are displayed in the results section

Results

- The values of the cervical resistance during CCBD on the upper pressure-sensitive film (PSF), which were measured in the zone of the **internal cervical os (ICO)**, ranged from 0,144 MPa to 0,559 MPa, with an average of **0,402±0,097 MPa**.
- For the **external cervical os (ECO)**, the values of the cervical resistance during CCBD on the upper film ranged from 0,043 MPa to 0,467 MPa, with an average of **0,264±0,108 MPa**.

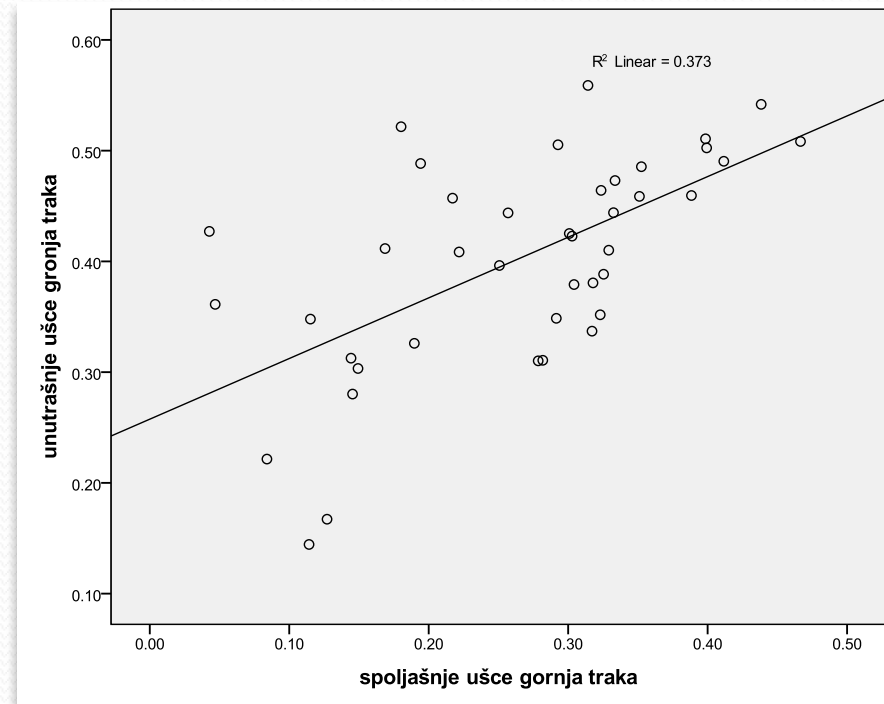

- The values of the cervical resistance on the lower PSF were measured in the zone of the **ICO** and ranged from 0,135 MPa to 0,582 MPa, with an average of **0,387±0,089 MPa**.
- As for the **ECO**, the values of cervical resistance on the lower PSF ranged from 0,047 MPa to 0,518 MPa, with an average of **0,243±0,120 MPa**.

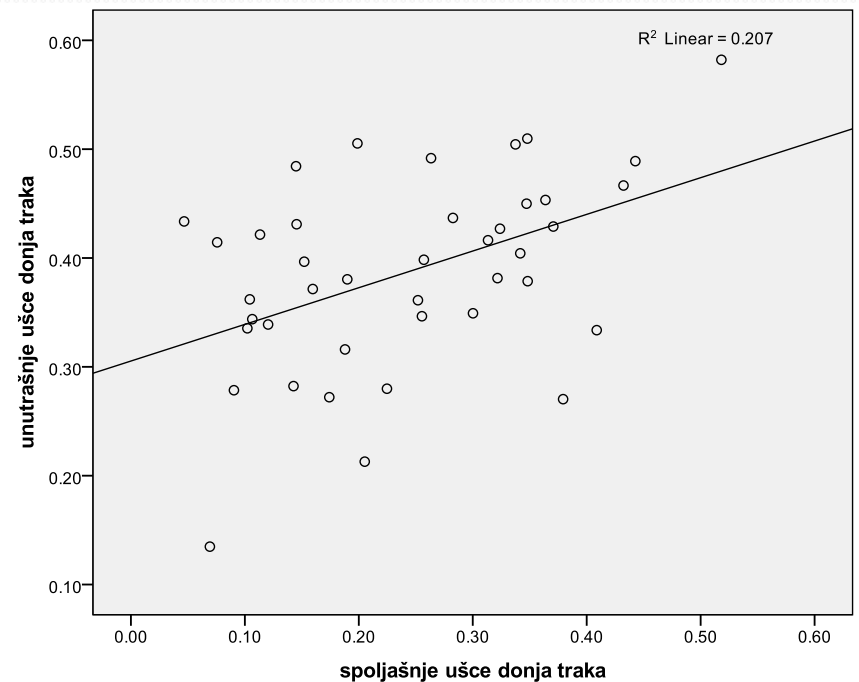

- Further analysis showed that the values of cervical resistance in the zone of the ICO are in the positive statistical correlation with the values of the cervical resistance measured in the zone of the ECO ($p=0,000$).
- No statistically significant correlation was found between the values of the cervical resistance measured in the zone of the ICO and the number of previous births or the number of previous miscarriages.

Internal cervical os

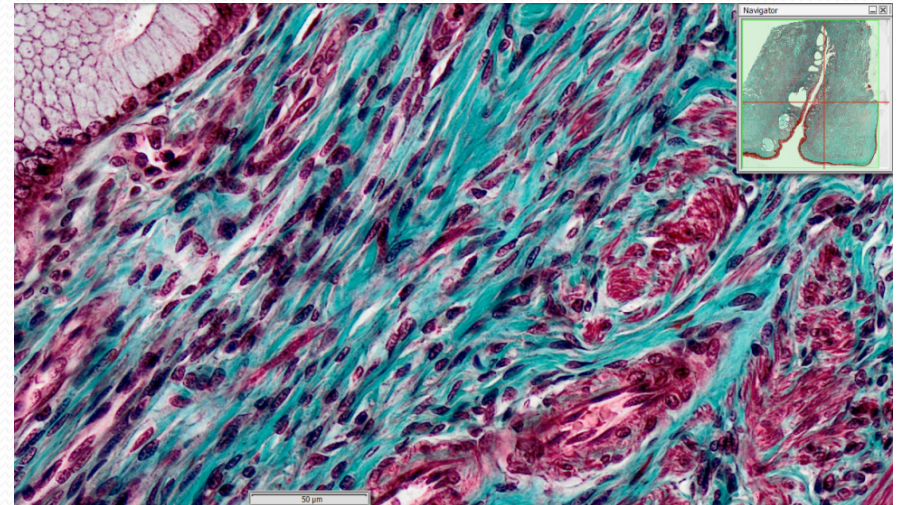

External cervical os

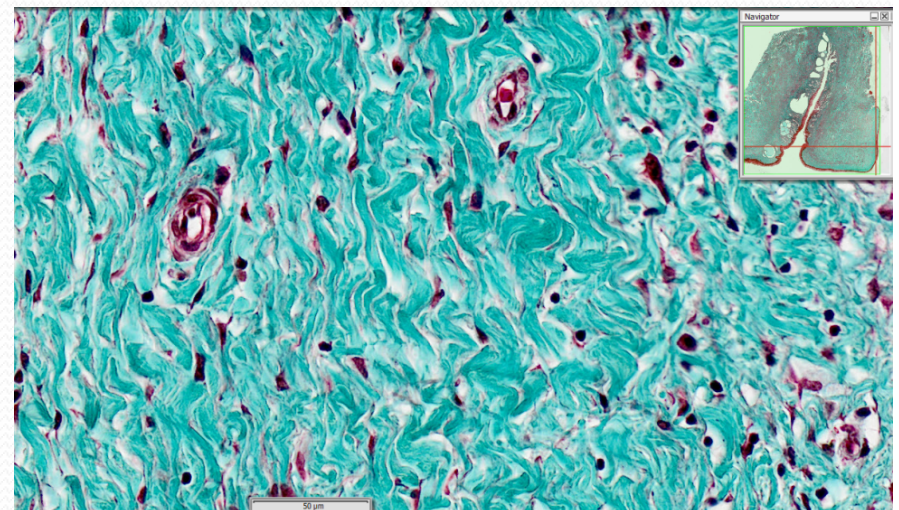

- Processed pressure-sensitive films gave us insight into the map of the cervical resistance during dilatation with CCBD system.
- The zones of the highest resistance are matched with the anatomical sites of the inner and external cervical ossa of the cervix, predicted by cervical dimensions acquired by an ultrasound, prior the intervention.

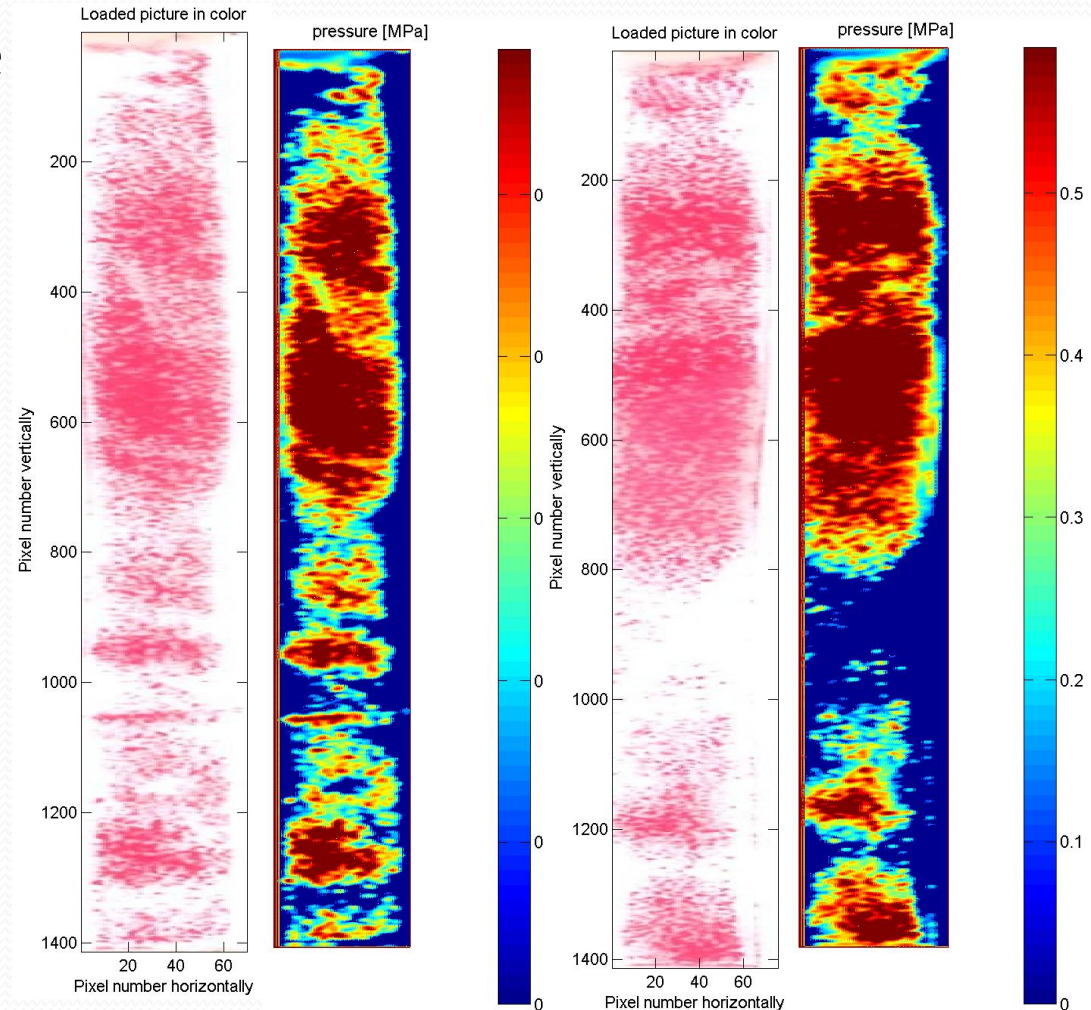

Discussion

- **With the use of the CCBD system and the application of the PSFs, we managed to locate every point of resistance along the upper and lower sides of the cervical canal.** An analysis of the PSFs showed that the points of highest resistance are in the zone of the ICO and that these values are much higher than those in the zone of the ECO for both pressure-sensitive films. The reason for this derives from the difference between the two cervical ossa; with the exception of densely packed collagen fibres, the **ICO contains a high concentration of muscle fibres arranged in two circular layers.** However, a statistically positive correlation exists between the values of cervical resistance measured in the zones of the inner and external cervical ossa for both of the pressure-sensitive films. That means that despite that the ICO is the centre of cervical resistance during CCBD, the dilatation occurs only after simultaneous loosening of both cervical ossa.

- 
- These findings were in accordance with those of other studies of the mechanical properties of the uterine cervix. On the contrary, in our study no statistically significant correlation was found between values of cervical resistance and the number of previous miscarriages. This result is opposite to that of previous studies; the reason for this contradiction might be found in the fact that both the cervical resistance index and the elastic properties of the cervix were investigated in non-pregnant women, while our study on cervical resistance was performed in women prior to the termination of unwanted pregnancies, before ten weeks gestation.

Conclusion

- During continuous controllable balloon dilatation, the internal cervical os is the centre of cervical resistance, and the values do not decline with the number of miscarriages or the number of previous births.

Dilatation curve

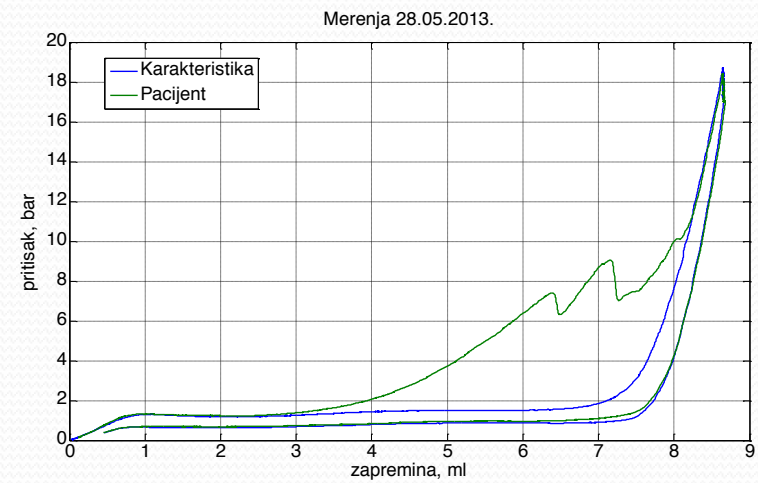
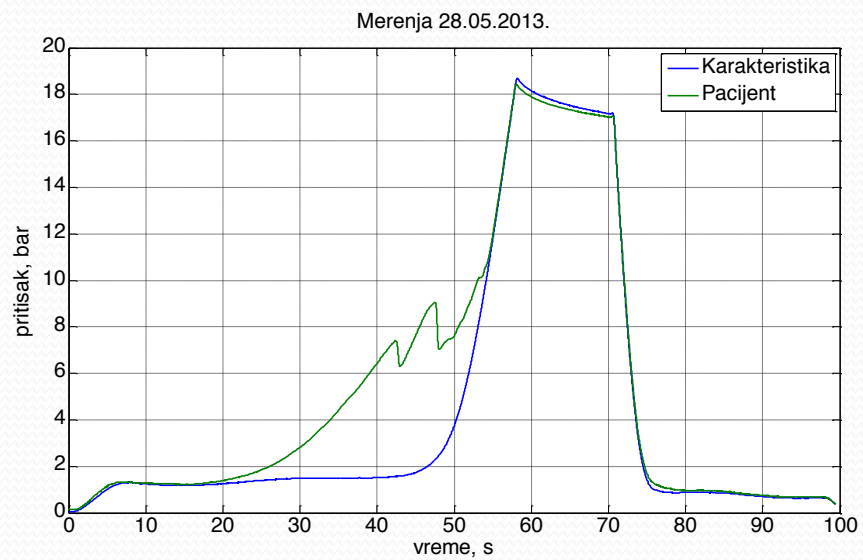

Димензије грлића: дужина 40мм, ширина 24мм, дебљина 27мм

Горња трака

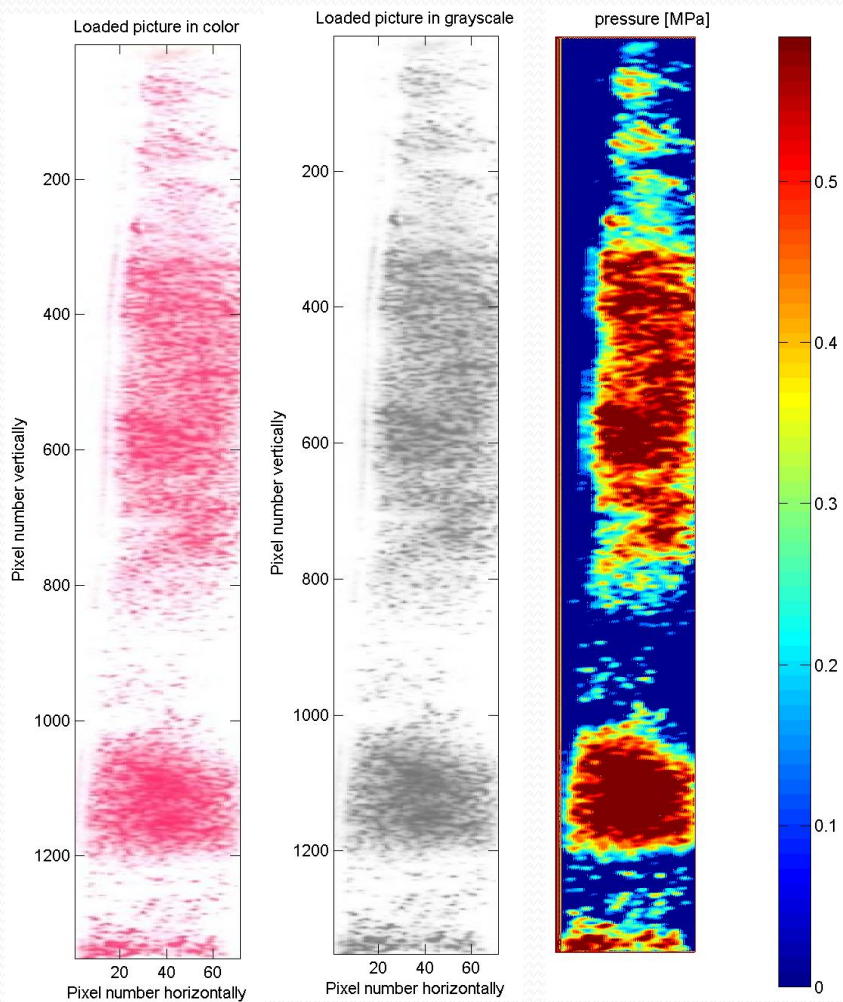

Доња трака

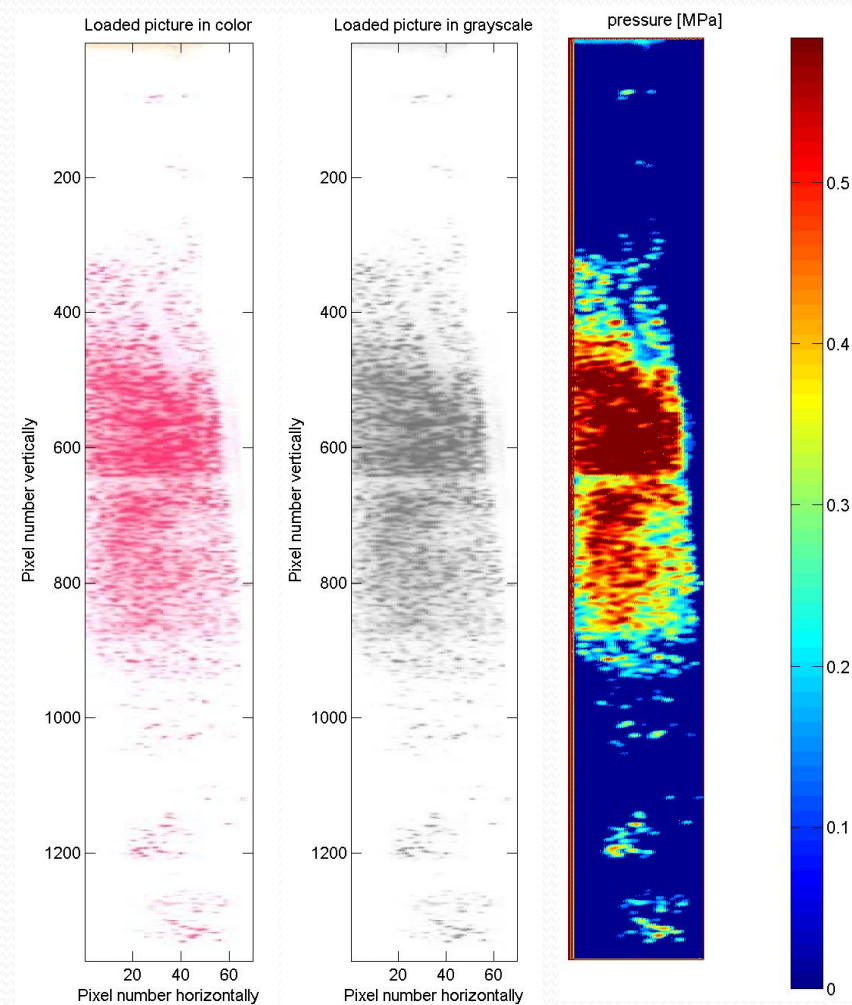

Корелација вредности измереног отпора

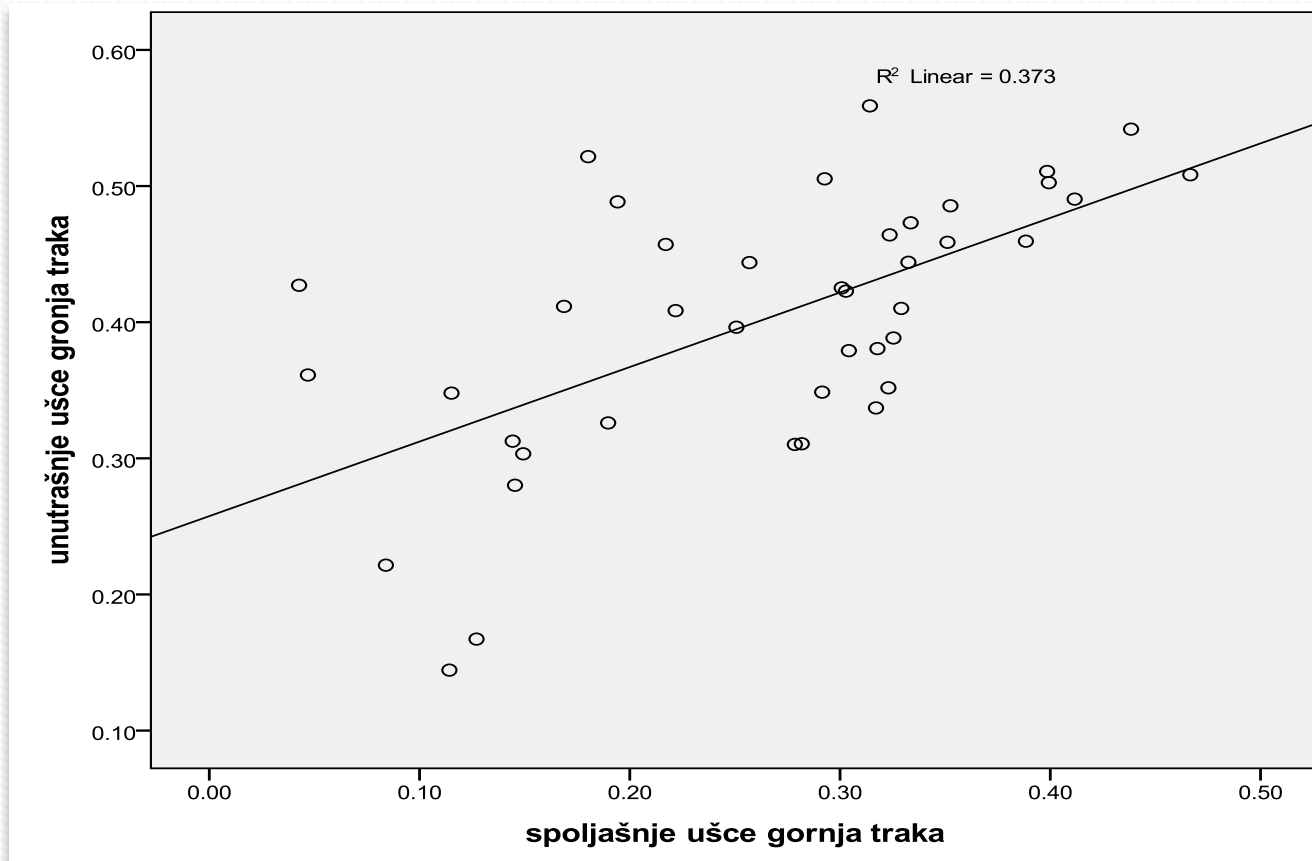

Корелација вредности измереног отпора

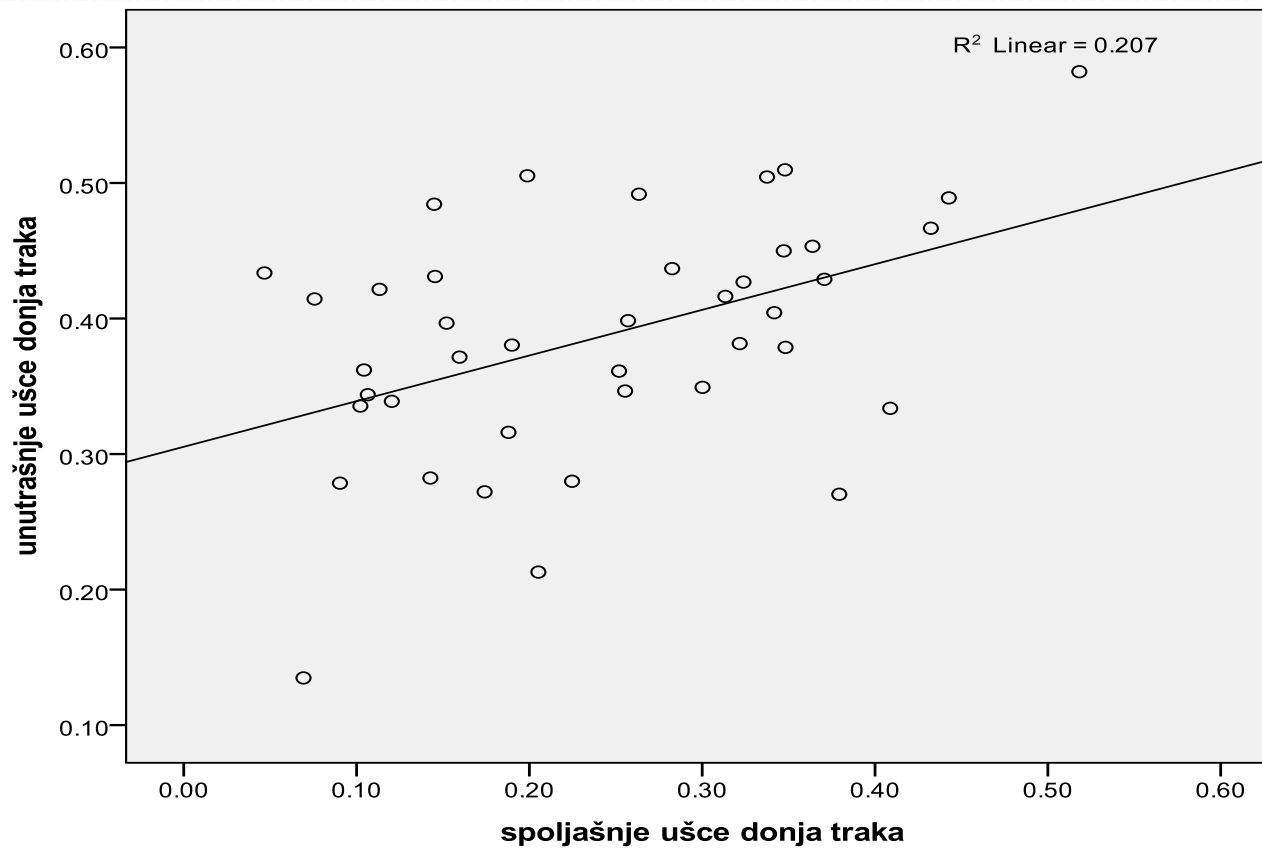

Gynedd

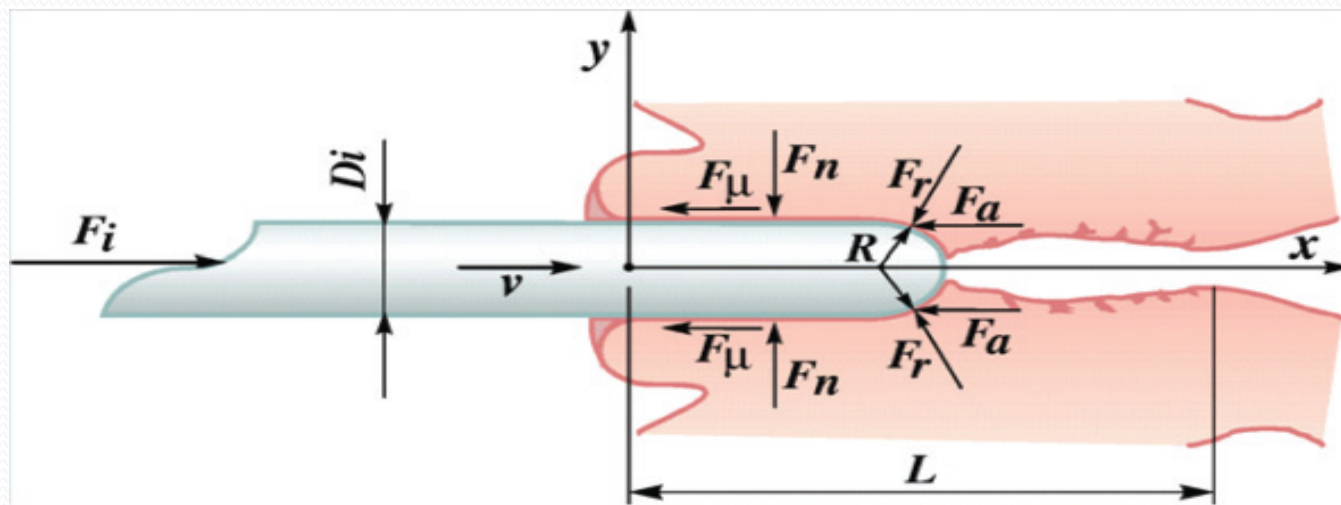
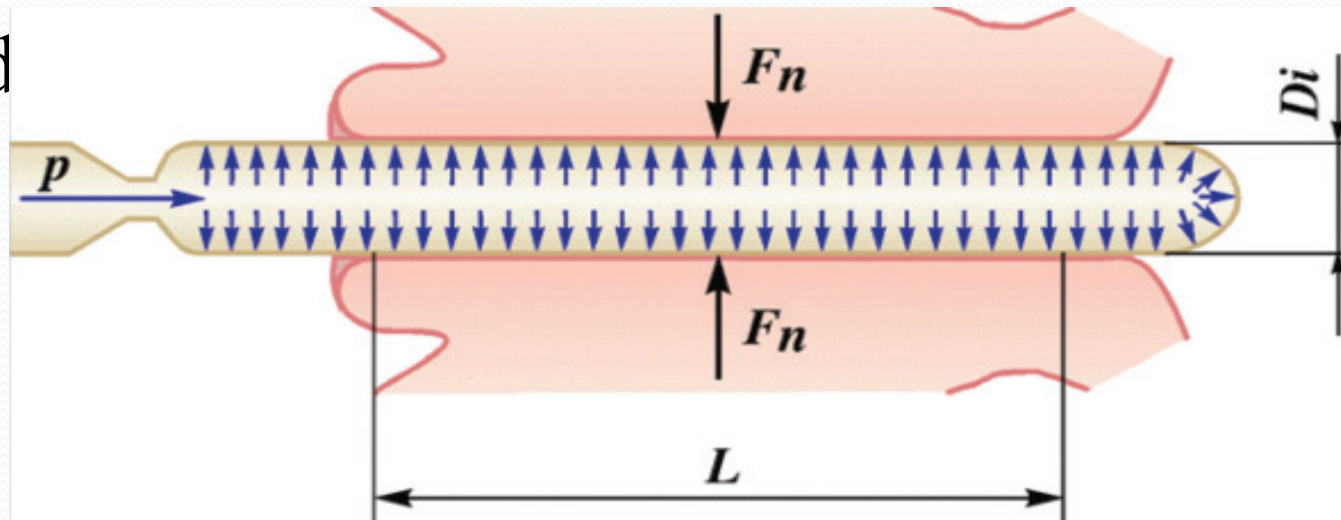

Figure 1

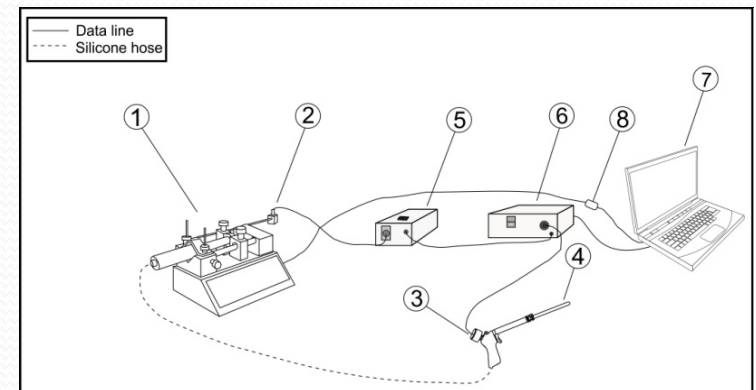
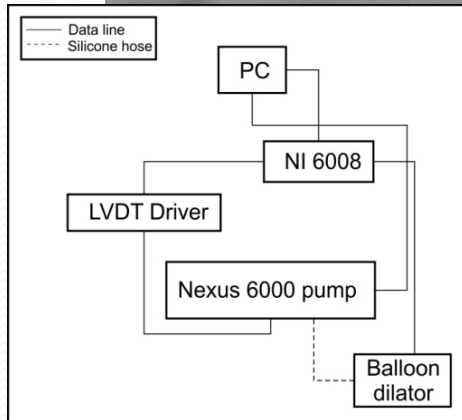
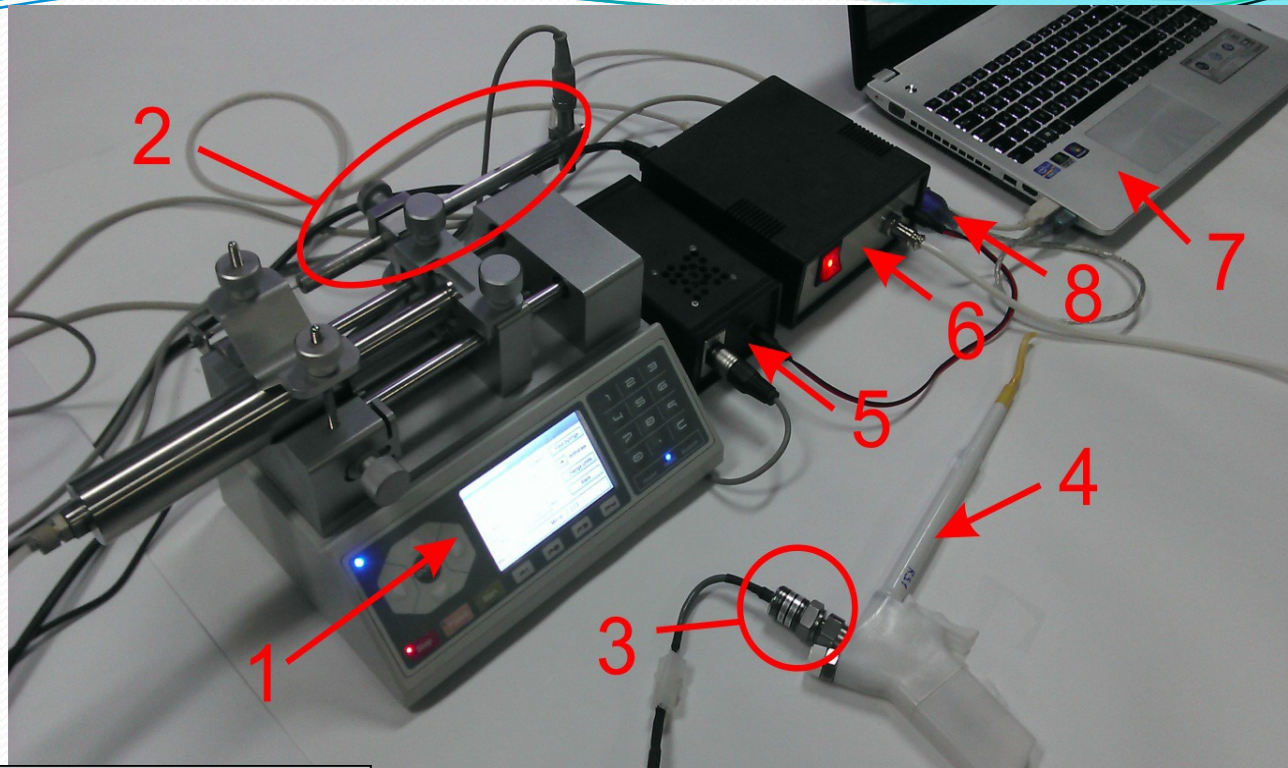
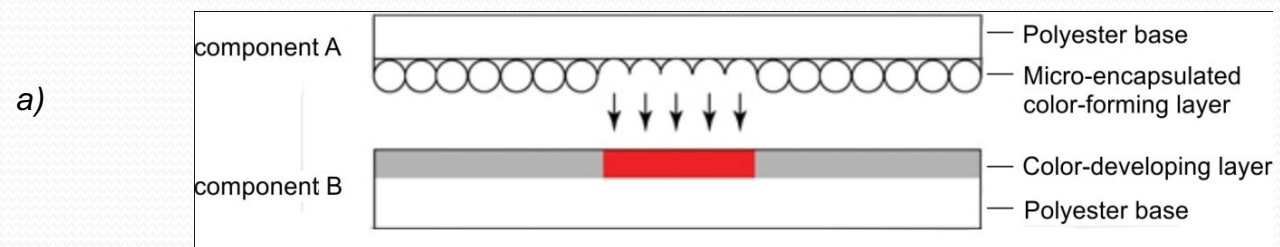

Figure 2



b)



A) Upper PSF

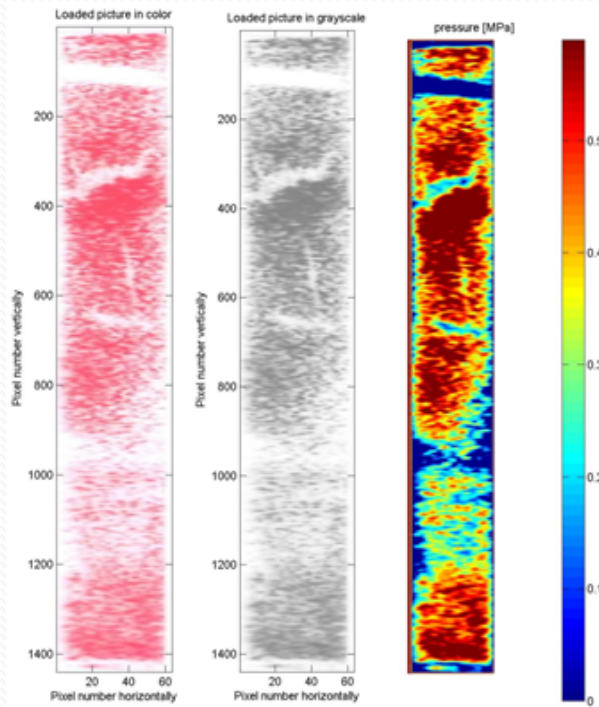

B) Lower PSF

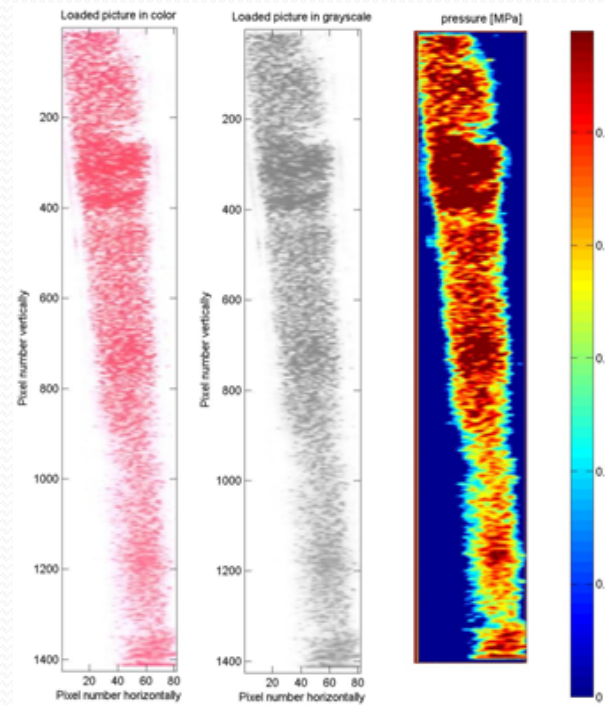

A) Upper PSF

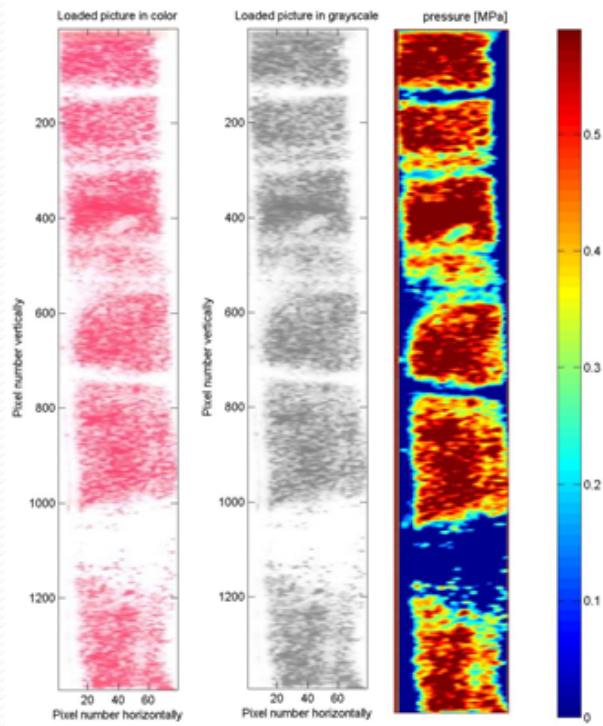

B) Lower PSF

